

Linear Grilles

STAINLESS STEEL AND BRASS LINEAR BAR GRILLES

description

Linear bar grilles ideally suited for wall, cill or floor applications. Grilles can be supplied in modular units or 2000mm sections for continuous runs.

Manufactured from Brass or stainless steel blades pitched at 12.5mm centres.

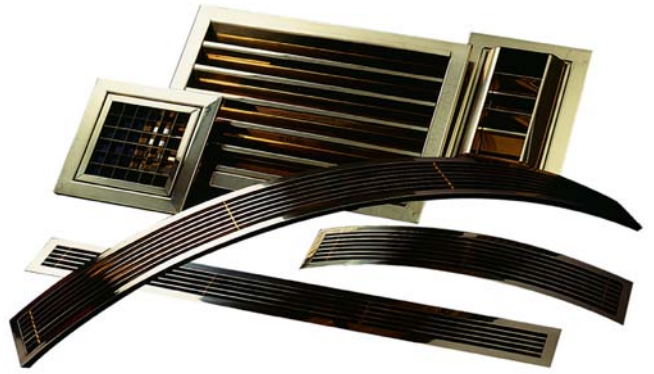

type

F1N - F15N - F1B

F1N = 0° deflection 3mm blade
F15N = 15° deflection 3mm blade
F1B = 0° deflection 6mm blade *

(* suitable for floor use)

options

BMA = Bronze Metal Antique
CP = Chrome Plated
NP = Nickel Plated

finish

SS: Stainless steel

DB = 240 grit (dull buff)
P = Polished

*standard grade 304, 316 available on request:

Brass: SB

P = Polished
L = Clear Lacquered

ordering details

example:	type	flange	metal	finish	opening	size	quantity
	F1N	/ 25S	/ SB	/ PL	/ Width 2000mm	/ Height 100mm	/ 6

Linear Grilles

STAINLESS STEEL AND BRASS LINEAR BAR GRILLES

0° Deflection

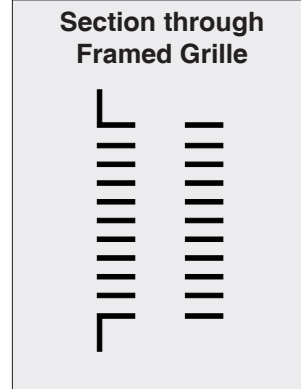
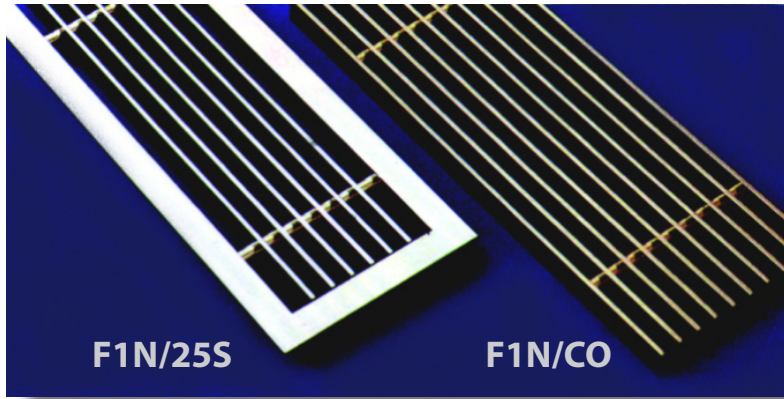

F15N 15° Deflection

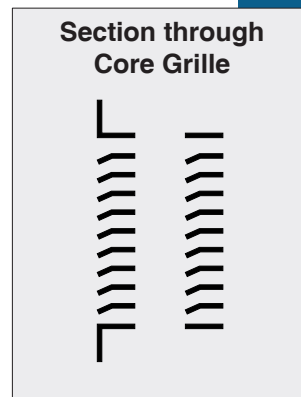
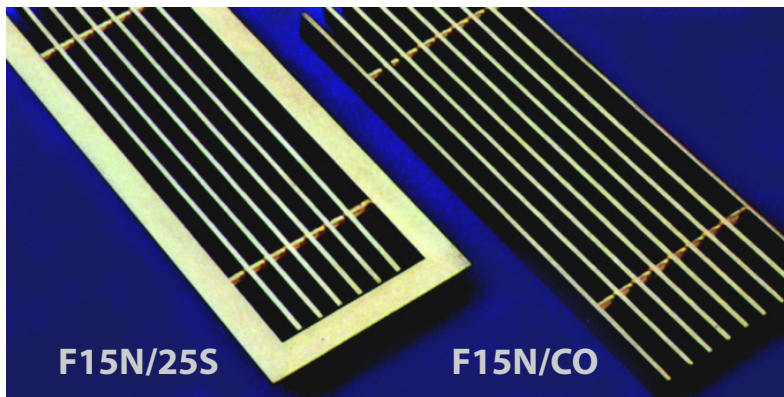

F1B 0° Deflection

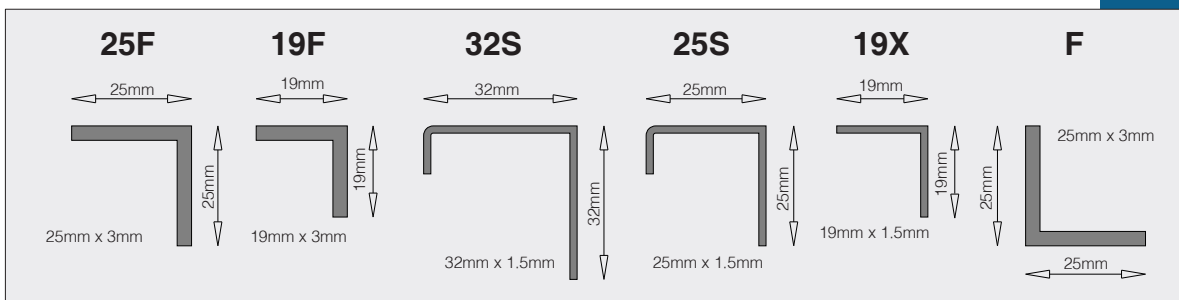
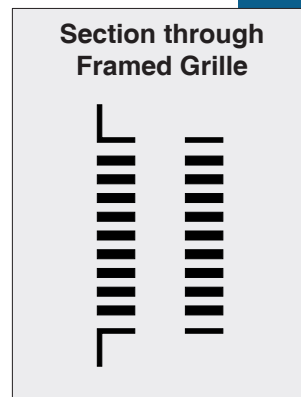
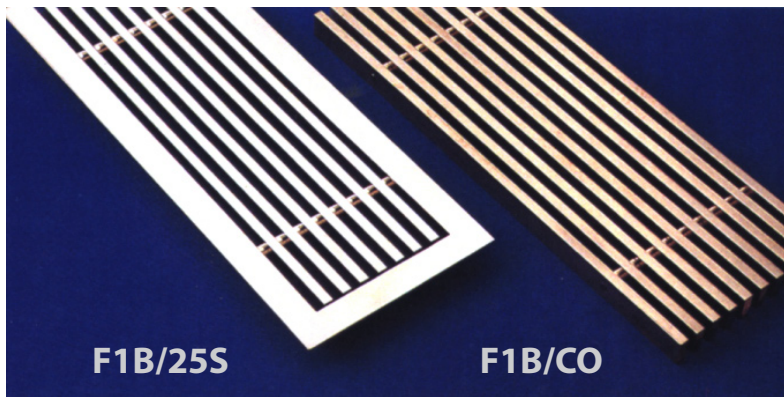

NOTE: for floor use 25mm x 25mm x 5mm

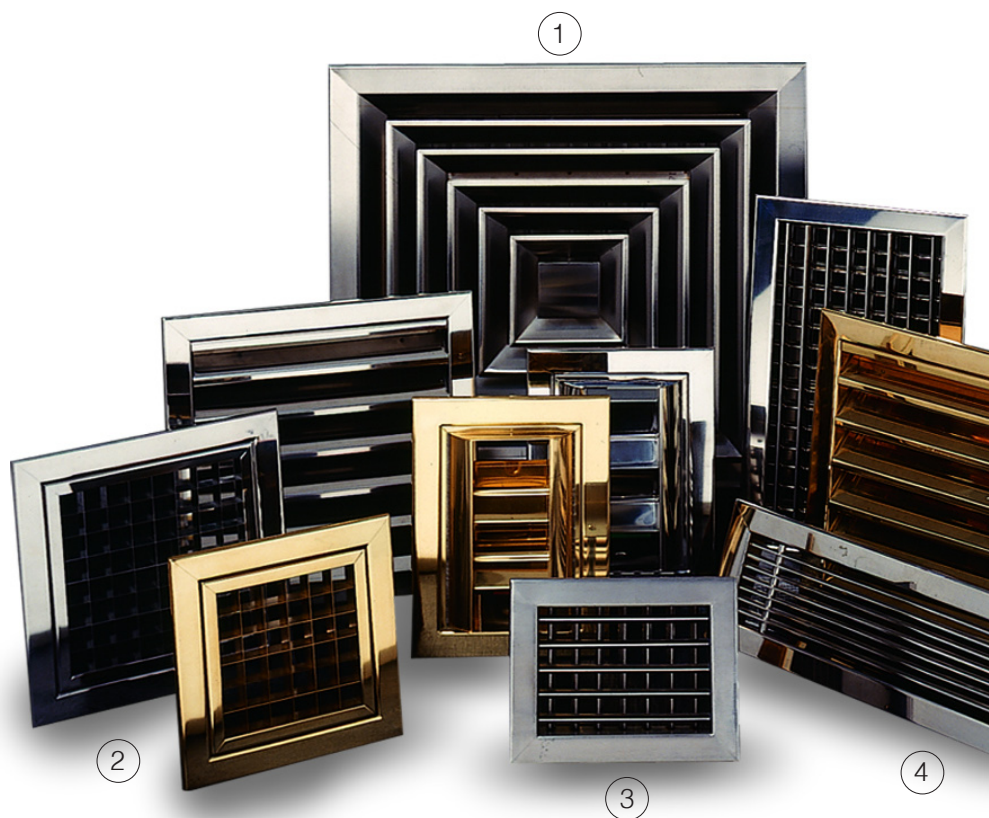

key

- | | | | |
|----|-------------|---|--------------------------|
| 1: | IC4 | : | 4 Way Diffuser |
| 2: | E25C | : | Eggcrate Grille |
| 3: | DDH | : | Double Deflection Grille |
| 4: | F1N | : | Linear Bar Grille |
| 5: | OMF | : | Louvres |
| 6: | DJ | : | Drum Jet Diffuser |

NOTE: Stainless steel products can be manufactured to suit offshore specifications.

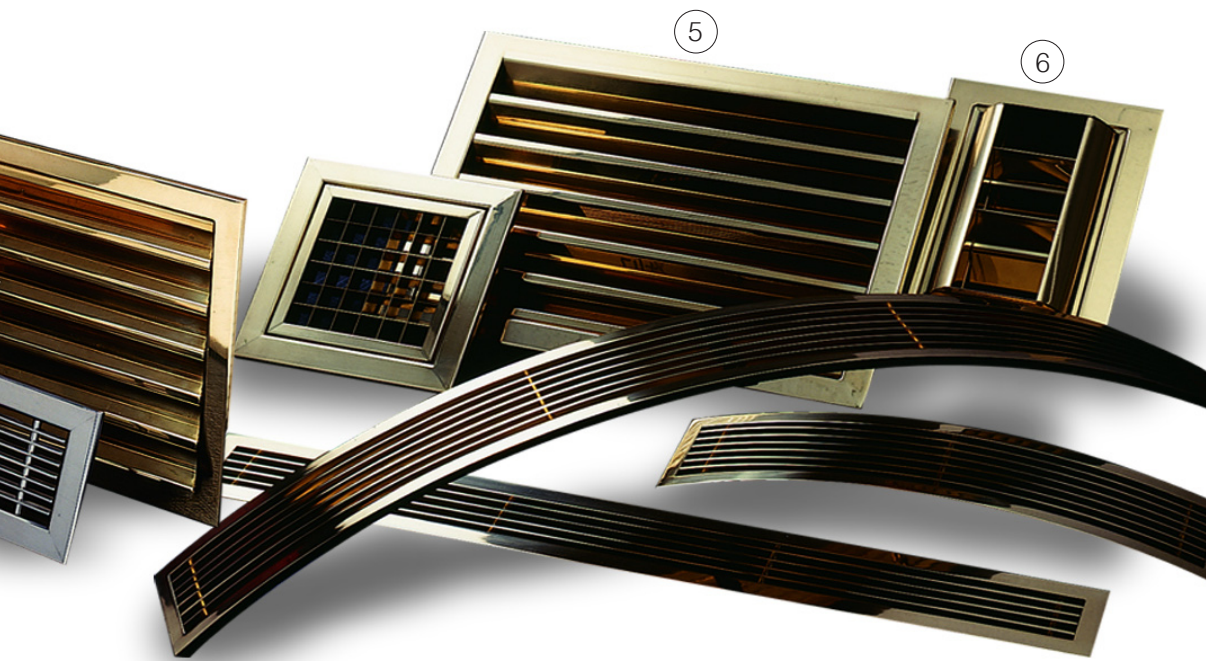

Stainless Steel and Brass Grilles



JC VENTS

JC House,
Hurricane Way,
Wickford Business Park,
Wickford,
Essex. SS11 8YB,
UK.

Tel: +44 (0) 1268 561122
Fax: +44 (0) 1268 560606
email: info@jcvents.co.uk
web: www.jcvents.co.uk